



Guardian
Warm Roof



Guardian warm roof conversion system

Installation Guide



Conservatory walls consist largely of glazed elements including windows and doors that may include structural mullions or may be strengthened with internal structural reinforcement inside hollow sections. Modern conservatories are likely to be marked in accordance with BS EN 14351-1:2006 + A1:2010.

The Guardian Roof System is designed to be of similar weight to a glass roof of equal size, so it follows that the existing glazed walls, if correctly specified for a the original glazed roof, should be capable of supporting the replacement Guardian Roof System.

It is the sole responsibility of the installer to establish the structural suitability of the existing conservatory wall system, to establish the location of any structural or reinforcing elements, and to ensure that the Guardian Roof System is fixed to the existing structural elements so that gravity and wind loads are transferred safely through the existing walls to the conservatory foundations.

The following guide has been created to assist in the fabrication and installation of the Guardian Roof. Please note that each roof is individual and will be fabricated to suit various shapes and sizes.

Each roof supplied will be accompanied by a roof layout plan and this guide. Your fabricator will be available to provide installation technical support.

Roof Layout Plan

Please refer to the roof layout plan prior to commencing installation. It is very important that the roof fits the windows layouts and that all the windows are fully reinforced. All components are numbered to match the roof layout plan for ease of installation.

Tools required

Cordless drill, angle grinder, silicone gun, tape measure, hand saw, 10mm spanner and 10mm nut spanner, 10mm ratchet, snips, staple gun, screwdriver, foam gun and expanding foam.

Guardian warm roof construction

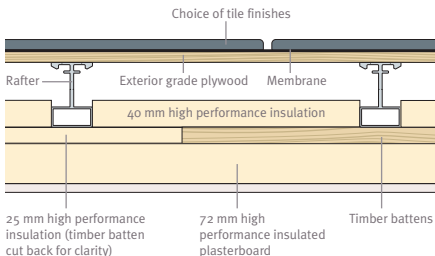

Step 1: Box gutter



Fix box gutter to wall and seal using suitable sealant. Place ringbeam on the side lip of the box gutter and fix in place by screwing up through the lip with a 25mm window screw. Ensure not to puncture the box gutter itself. For the best internal finish use insulated plasterboard under box gutter using timber battens.

Step 2: Ringbeam

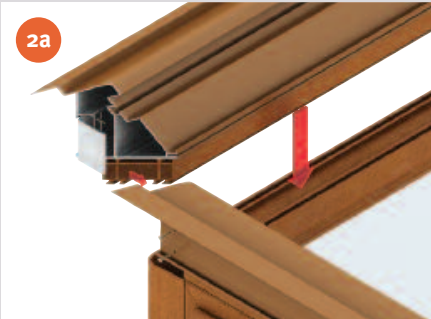

Cleats to be inserted internally into the ringbeam and fixed using 25mm stainless steel window screws.

Ringbeam and packer should be installed flush with inside of window frame. Use 100mm stainless steel window screws at 600mm centres.

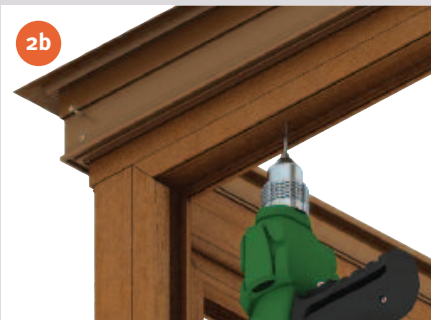

Remove existing glazing and fix through packer and eaves beam.

Cleats to be fixed at 32mm from the outside angle of the ringbeam on die lines.

Step 3: Assemble rafters

Gable rafters to be bolted to house wall and secured at 300mm centres using suitable fixings determined by the wall construction.

Ensure Stainless Steel Cleats provided are used when fixing to the house wall at the top and bottom of wall rafter.

Stainless steel cleats must also be used at gable front end.



Edwardian stainless steel cleat Victorian stainless steel cleat

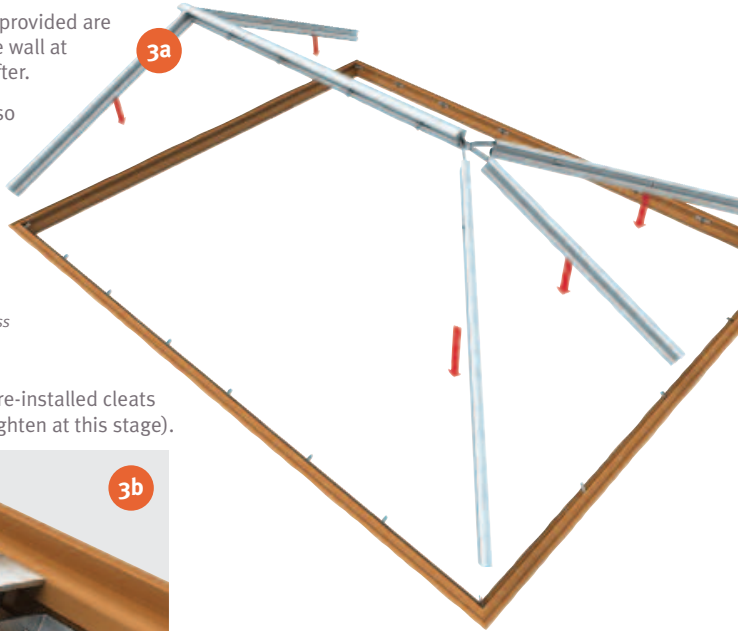

Fix rafter to ringbeam using pre-installed cleats and bolts provided (loosely tighten at this stage).

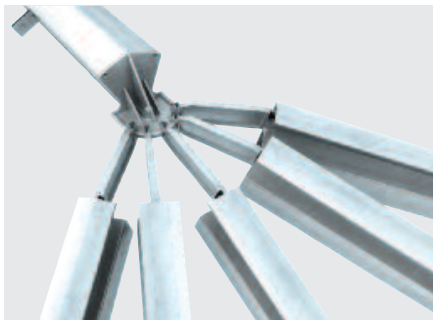

Edwardian conservatory

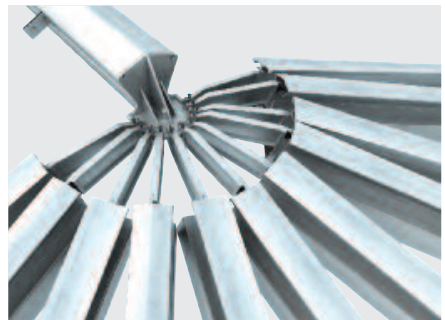

Victorian conservatory option

Step 3: Assemble rafters

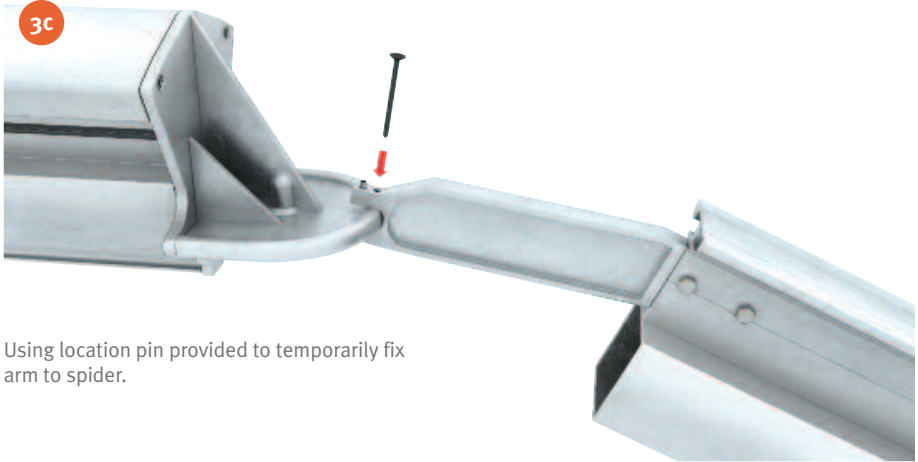

Using location pin provided to temporarily fix arm to spider.



Temporary fix remaining rafters including any pre-engineered window framing (if required).

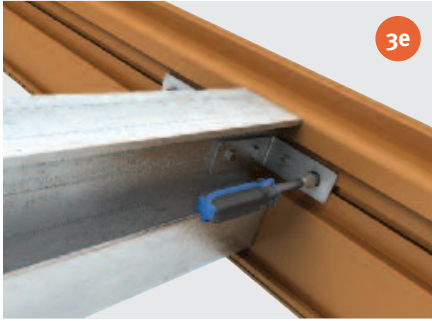

Ensure all roof sections are aligned to the pre-engineered positions and tighten into place.

For edwardian/victorian hip cleats tighten bolts on rafters first before tightening to ringbeam.

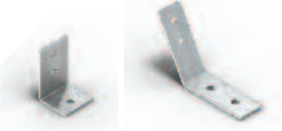

*Edwardian
aluminium cleat*

*Victorian
aluminium cleat*

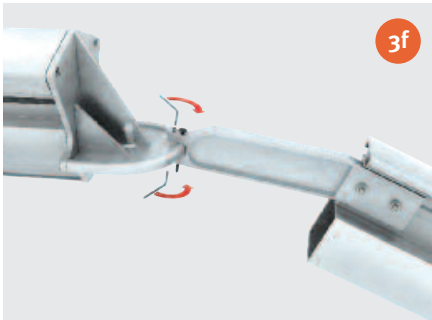

Tighten pre-installed grub screws using alan key. Please ensure grub screws are not overtightened.

Step 4: Timber battens



Fit 25mm timber battens at maximum 400mm centres to underneath of rafters. Fixings are to be 50mm window screws.



Batten out entire roof structure. Batten over window opening and cut back to suit.

Step 5: Rafter Insulation



From outside insert **40mm** insulation board between rafters.

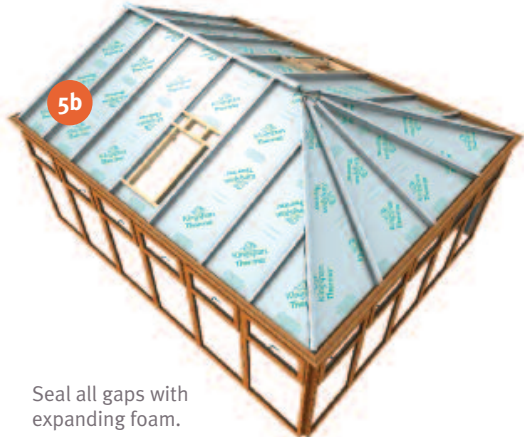

Seal all gaps with expanding foam.

Step 6: Exterior plywood & window frame

Fix timber sheets to rafters.

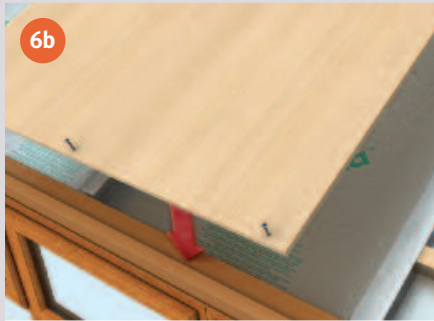

Timber out roof as per schedule. Timber sheets to be fixed at 200mm centres using 20/25mm self drilling screws.



Fix brackets to the V notch on roof window frame prior to installation.

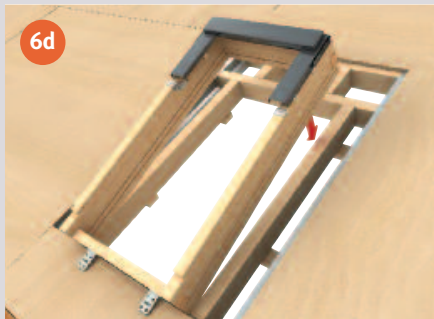

Install roof window frame into pre-formed opening within rafters.

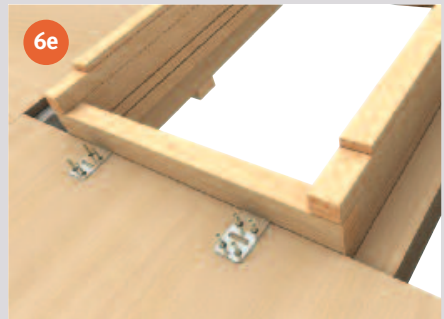

Fix frame to timber ply through brackets using screws supplied within roof window pack.

Step 7: Membrane & roof tile



7a

Cover with vapour permeable underlay with a vapour resistance of less than 0.25MNs/gram as required by BS5250: 2002. Overlap all joints of underlay by 150mm and staple down to timber sheets. Over run ringbeams by 100mm and up outer wall by 50mm.

Torn underlay up window frame and staple to topside.



7b

Fix watercourse to outer wall. Starting bottom right corner of the roof with a full roof tile, fix to lip of ringbeam and into the corner of the watercourse (allow 4 x 16mm screw fixings per tile).

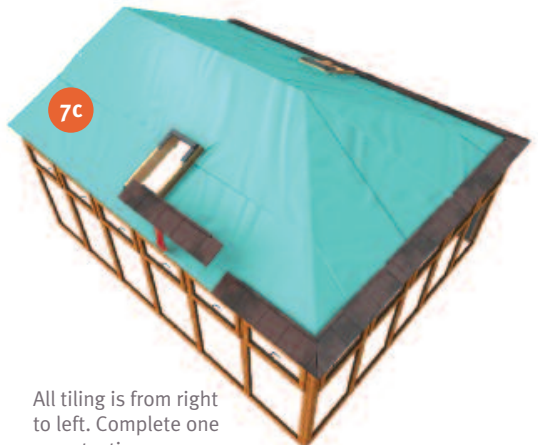

7c

All tiling is from right to left. Complete one row at a time.

For the second course always start with half a tile.

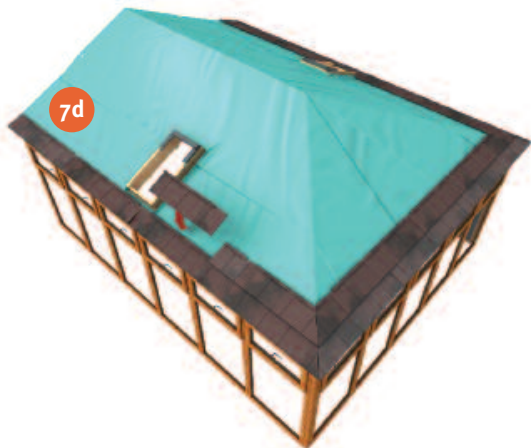

Dependant on height of roof window 1-3 tiles should be fitted below window before bottom flashing is installed.

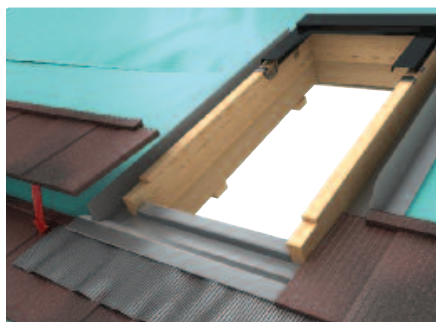
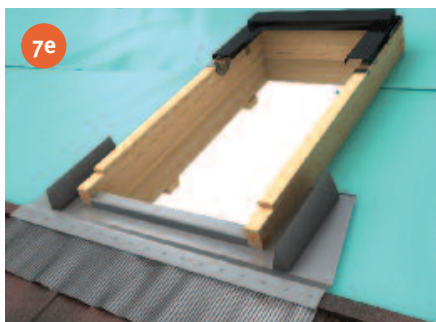

Roof window flashing to be installed to roof window pack instructions.

Step 8: Standard Ridge & end cap

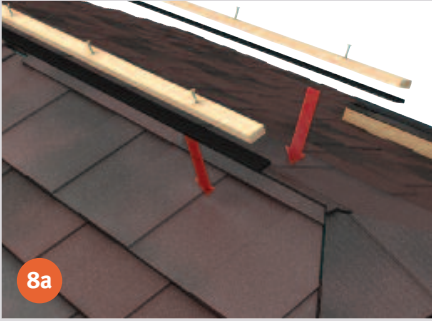

Apply foam tape to underneath the 25mm treated timber batten. Using the profile ridge and hip for position fit timber battens and screw into place.



Position delta ridge over batten and fix side on. Use touch up kit provided to hide screw heads.

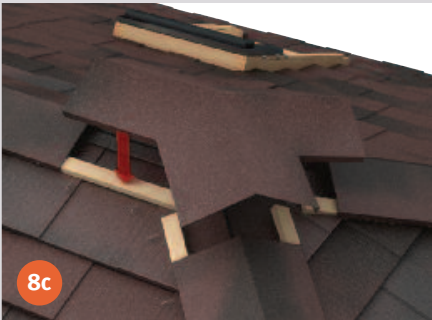

Follow instructions 8a and 8b for end capping. Fix rafter cap over delta ridge profile at verge.

Optional small ridge



In cases of stretched Victorians and off angles on ridges, a smaller ridge is available to allow for angle adjustment. Paint cut edges with touch-up kit.

Optional end capping



3-way capping



5-way capping



Rafter cap

Step 9: Internal Insulation



Install **25mm** insulation between battens and apply expanding foam to the spider assembly.

Please ensure electrical wiring is in place before 25mm PIR is positioned.



Cut and mitre **72mm** insulated plasterboard, fix into position, tape all joints and seal against window frame.

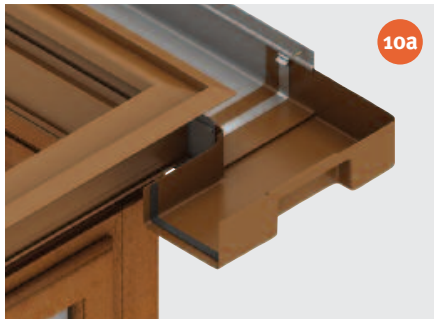

Step 10: Gutter adaptor

Fit box gutter adaptor into the box gutter and seal using suitable wet sealant. Seal between ringbeam/extension and window line with appropriate sealer. Also seal against house wall.

25mm PIR Insulation to be used under Box Gutter for insulating value and to avoid the risk of condensation.



Step 11: Gutter

Twist fit gutter brackets to ringbeam prior to installing gutter and downpipe.

Step 12: Valley Gutter



Place valley tray on top of breather membrane within the valley itself.

Fix flaps either side directly into membrane and ply.

Tile into valley cutting at angle of roof.

Seal where necessary.



Optional mansard ceiling

Use appropriate low voltage down lighters with cowl.



call FREE: 0800 0665832
email: info@guardianroof.co.uk
www.guardianroof.co.uk

Important Guardian Roof have taken great care to ensure that the information in this installation guide is accurate and is supplied in good faith. However Guardian Roof issues this guide without warranty or guarantee of any kind and accepts no responsibility as to how the information is interpreted. Health and safety regulations are the sole responsibility of the installer and totally unconnected to Guardian Roof. The Guardian Roof is continually evolving and changes to product and specification can change at any time. Updates to this guide will be posted on our website immediately and all customers will be informed by electronic mail. The website is www.guardianroof.co.uk